

ARTOME M10

USER MANUAL



TABLE OF CONTENTS

1	IMPORTANT SAFETY INFORMATION	6
1.1	Safety symbols	6
1.2	Warnings and cautions	7
1.2.1	Forbidden substances	7
1.2.2	Danger to senses	7
1.2.3	Other warnings	7
1.3	Risks of electric shock	8
1.3.1	Unplug and call service	8
1.3.2	Power plug	8
1.3.3	Power cord	8
1.3.4	Unsuitable environment	9
1.3.5	Power source and voltage	9
1.3.6	Disassembly and foreign objects	9
1.4	Prohibitions	9
1.5	Notes	10
1.6	Other graphical symbols	10
1.6.1	Risk of electric shock	10
1.6.2	CE marking	10
1.6.3	WEEE	11
1.6.4	Read the Manual	11
2	TERMS AND ACRONYMS	12
3	PRODUCT DESCRIPTION	13
3.1	Intended Use	13
3.2	Product Overview	13
3.3	Product features	15
3.3.1	Projection and imaging	15
3.3.2	Sound	15
3.3.3	Wireless connections	15
3.3.4	Videoconferencing	15
3.3.5	Hybrid events and learning	16
3.4	Using Radio Equipment	16
4	UNPACKING	17
5	USER INTERFACE AND CONNECTIONS	18

5.1 Control Panel	18
5.2 Light indicators	18
5.3 Connections	19
6 PREPARATIONS	21
6.1 Connecting additional devices	21
6.1.1 Microphones	22
6.1.2 External sound system	22
6.1.3 Installing Web camera	22
6.1.4 Installing speaker phone	23
6.2 Image adjustment and unit placement	23
6.2.1 Optimizing image	24
6.2.2 Adjusting image size	24
6.2.3 Adjusting focus	25
6.2.4 Adjusting image shape	25
6.2.5 Lifting the image	26
7 FIRST TIME USE	27
8 DAILY USE	29
8.1 Connecting with a wire	29
8.2 Connecting with a wire	29
8.3 Wireless connections	29
8.4 Videoconferencing	29
8.5 Streaming – Hybrid events and hybrid learning	29
8.6 Audio use	30
9 MAINTENANCE	31
9.1 Cable management	31
9.2 Cleaning the casing	31
9.3 Vacuuming the projector space and fans	31
9.4 Cleaning the lens	31
9.5 Product service program	31
10 TROUBLESHOOTING	33
11 SUPPORT AND SERVICE	34
11.1 Getting more information	34
12 DISPOSAL	35
12.1 Disposal of electronic components	35
12.2 Disposal of packaging waste	35

13 TECHNICAL DATA	36
13.1 General specifications	36
13.2 Technical specifications	36
13.3 Projector specifications	36

1 IMPORTANT SAFETY INFORMATION

- Read and understand this manual and its safety instructions before using this product. Failure to do so can result in serious injury or death.
- Follow all the instructions to avoid electric shocks or other hazards that may result in property damage and/or severe or fatal injuries.
- To use this product, you must fully read and understand the contents of this user manual or Artome M10 - Quick User Guide.
- To connect Artome M10 with additional appliances, such as microphones, external speakers, and wireless collaboration devices, you must fully read and understand the contents of this user manual.
- Keep all safety information and instructions for future reference and pass them on to the next users of the product.

1.1 Safety symbols

To prevent personal injury or damage to property, the following symbols are used to show dangerous operation or handling. Make sure you understand them properly when reading the guide.



WARNING

This note indicates information that, if ignored, could possibly result in serious personal injury or even death due to incorrect handling.



CAUTION

This note indicates information that, if ignored, could possibly result in personal injury or physical damage due to incorrect handling.



A risk of electric shock.









General mandatory action.

Table. 1.1 - 1. Explanation of safety symbols

	Do not do. General prohibition.
--	---------------------------------

Table. 1.1 - 2. Symbols indicating a specific prohibited action.

Symbol	Description
	Do not disassemble
	Do not touch
	Do not wet
	Do not use in wet areas
	Do not place on an unstable surface
	Do not spray

1.2 Warnings and cautions

1.2.1 Forbidden substances



WARNING

- Do not use sprays containing a flammable gas to remove dirt or dust which is adhering to parts such as the projector lens or fans of the Artome unit. The projector which is installed inside Artome unit becomes hot during use. The gases may ignite and result in a fire.
- Use a vacuum cleaner or hand-operated air blower to remove dirt or dust that has adhered to parts such as the lens of the projector or the fans.
- Do not use the projector in places where flammable gases or explosive gases may be present in the atmosphere.
- Do not use high pressure air (air compressor or equivalent) to clean the unit. Very high air pressure may damage the unit.
- Do not place any objects that are easily flammable in front of the projector's lens. Otherwise, a fire may occur.

1.2.2 Danger to senses



WARNING

- Do not look into the projector lens when the Artome unit is on. The bright light can damage your eyes. Families with small children should be especially careful.
- Also, do not look into the lens using optical devices such as loupes or telescopes.
- Do not use Artome unit when a person is close to it. High sound pressure can cause permanent hearing damage.
- Do not connect video or audio connectors when the Artome unit is on. This may cause high sound pressure which can cause permanent hearing damage.

1.2.3 Other warnings



WARNING

- During projection, do not block the light from the Artome unit's projector. If the light from the projector is blocked, the area on which the light shines becomes hot which could cause it to melt, burn, or start a fire. Also, the lens may get hot due to the reflected light which could cause the projector to malfunction. To stop projection, use the Pause function from User panel or turn off the Artome unit.
- Do not use the Artome unit without locking the castors. Earthquake or other cause may move the unit and hit to person or wall or object and may cause severe injury or malfunctioning of the unit.
- Do not sit or lay on the top of the Artome unit. Falling may cause severe injury.
- Do not loosen the grip when moving the Artome unit. The product may move on a sloping surface on its own and hit another person or damage property.
- Do not walk behind the product when the power cord is plugged in. A loose cord can cause a fall and serious injury.

1.3 Risks of electric shock

1.3.1 Unplug and call service



CAUTION

Unplug Artome from the outlet and refer all repairs to qualified service personnel in the following situations:

- Smoke, strange odors or strange noises come out of the Artome unit or the projector inside Artome.
- Liquid or foreign objects get inside the Artome unit or the projector inside Artome.
- Artome has been damaged.

If you continue using Artome as it is, it could cause an electric shock, fire, or even damage to eyesight caused by the projector inside Artome. Do not try to repair the Artome unit yourself.

Place Artome near an easily accessible outlet so that the plug can be unplugged immediately when an error occurs

1.3.2 Power plug



- Take care when handling the power plug. Failure to comply with these precautions could result in fire or electric shock.
- Follow these precautions when handling the power plug:
 - Do not overload wall outlets, extension cables, or power strips.
 - Do not insert the plug into a dusty outlet.
 - Insert the plug firmly into the outlet.
 - Do not hold the plug with wet hands.
 - Do not pull the power cord when disconnecting the plug; always be sure to hold the plug when disconnecting it.

1.3.3 Power cord



- Check the specifications of the power cord.
The power cord supplied with the Artome unit is intended to comply with power supply requirements for the country of purchase. Using an inappropriate power cord could result in fire or electric shock. If you use the Artome unit in the country where it was purchased, only use the power cord that came with the product. If you use the Artome unit in a country other than where it was purchased, use the correct power cord for that country.
- Do not use a power cord that is damaged.
Fire or electric shock may result.
- Follow these precautions when handling the power cord:
 - Do not modify the power cord.
 - Do not place heavy objects on top of the power cord.
 - Do not bend, twist, or pull the power cord excessively.
 - Keep the power cord away from hot electrical appliances.
 - Do not tie the power cord to other cables.

If the power cord becomes damaged (the core wire is exposed, the wire is broken wire, and so on), contact your dealer.

1.3.4 Unsuitable environment



- Do not use the Artome unit in locations such as kitchen counters, kitchens, or near humidifiers, where it is subject to humidity or dust such as kitchen counters, kitchens, or near humidifiers, or in locations subject to oil, smoke, or steam.
Doing so may result in fire or electric shock.
- Do not use the Artome unit where it may be exposed to rain, water, or excessive humidity. Fire or electric shock may result.
- Do not touch the plug during an electrical storm. Otherwise, you may receive an electric shock.

1.3.5 Power source and voltage



- Do not use a power source with a voltage other than those specified in the Operating manual. Use of a different power source may result in fire or electric shock. If you are not sure of the voltage available, consult your dealer or power company.
- This product is intended to be operated ONLY using the voltages listed on the back panel or connection panel. Operation using other voltages than those indicated may cause irreversible damage to the product and void the product's warranty. The use of AC Plug Adapters may allow the product to be used with voltages at which the product was not designed to operate. If the product is equipped with a detachable power cord, use only the type provided with your product or by your local distributor and/or reseller. If you are unsure of the correct operational voltage, please contact your local distributor and/or retailer.

1.3.6 Disassembly and foreign objects



- Never open the Artome User Panel, Connection panel or Power panel. Never attempt to disassemble or modify the Artome unit (including installed projector).
Electrical voltages inside the Artome unit can cause a fire, electrical shock, or severe injury.
- Do not place any containers of liquid or chemicals on top of the Artome unit.
Spilling liquid of any kind into the projector may result in fire or electric shock.
- Do not insert metal, flammable, or foreign objects into the Artome unit's vents or openings nor leave them nearby.
Doing so may result in fire, electric shock, or burns.

1.4 Prohibitions



- Never plug Artome into the outlet before the projector is installed and Artome unit is fully configured with Artome Virtual Installer application. Contact your dealer to carry out the installation work.
- Do not use microphones that are not supported by Artome. The microphone may not work properly and may cause distortion or feedback. Ask for supported microphones from your dealer or manufacturer.
- Do not transport the device without proper protection. The unit may be damaged. Always cover the unit with hardcase (optional accessory) when unit is moved in a car or by freight company.
- Do not store the device without proper protection from dust. The dust may damage the product when it is used again. Use included carton box for storing.
- Do not move the device without proper protection from dust. The dust may damage the product when it is used again. Use included carton box for storing.
- Do not move the appliance on uneven or bumpy surfaces. Castors may be damaged.

1.5 Notes



- Installing and uninstalling the projector in the Artome unit requires specialist knowledge. If installation work is not carried out correctly, the Artome unit may not operate properly. This may result in errors in product usage. Contact your dealer to carry out the installation work.
- Do not use or store the Artome unit in locations where it will be subject to dust or dirt. The quality of the projected image may decline, or the air filter of the projector may become clogged, resulting in a malfunction or fire. Use the provided cardboard cover to prevent this.
- Always feed external cables through the inlet at the bottom of the unit and close the door. Cables may break due to incorrect pressure on the connectors.

1.6 Other graphical symbols

This chapter lists the rest of the graphical symbols used on the product or elsewhere.

1.6.1 Risk of electric shock



**RISK OF ELECTRIC SHOCK
DO NOT OPEN**

Risk of Electrical Shock. Do Not Open! The voltage level in this equipment may be lethal. No user serviceable parts inside. For service, refer to qualified service personnel.



— This symbol is intended to alert the user to the presence of uninsulated "dangerous voltage" within the product's enclosure that may be of sufficient magnitude to constitute a risk of electric shock.



— This symbol is intended to alert the user of the presence of important operating and maintenance (servicing) instructions in the literature accompanying the appliance.

1.6.2 CE marking



The CE Marking on the product is the manufacturer's declaration that the product complies with the essential requirements of the relevant European health, safety, and environmental protection legislation. The number behind the CE mark is the identification number of the notified body where the conformity assessment procedure is applied. Notified body is not mandatory for Class I equipment.

1.6.3 WEEE

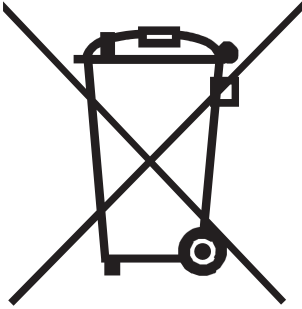

The symbol on the product, the accessories, or packaging indicates that this device must not be treated as unsorted municipal waste but must be collected separately.

1.6.4 Read the Manual

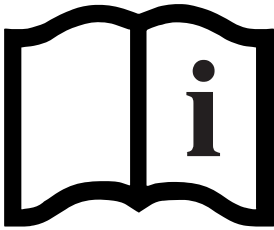

Read and understand the manual and its safety instructions before using this product.

2 TERMS AND ACRONYMS

Term or acronym	Description
2.1. Audio	Loudspeaker system consisting of two front speakers and a subwoofer for a low bass sound.
Active speaker	A loudspeaker with an integrated amplifier.
AEC	Acoustic Echo Cancellation.
Bluetooth connection	Wireless short range data connection.
Cardioid microphone	Microphones that pick up sounds with high gain from the front and sides but poorly from the rear.
DSP	Digital Signal Processor. Digital technology to enable versatile sound processing.
HdBaseT	Connectivity standard for transmission of uncompressed very high definition video, digital audio, DC power, Ethernet, USB, and other control communication up to 100 m (328 ft) in length.
HDMI	High-Definition Multimedia Interface. An audio/video interface for transmitting uncompressed video data and compressed or uncompressed digital audiodata.
HybriDock™	An USB audio interface which converts analog audio sources, such as microphones to digital USB microphones and transmits USB audio from a laptop to the Artome M10 sound system.
Keystone effect	The apparent distortion of an image caused by projecting it onto an angled surface
Phantom power	DC electric power transmitted through microphone cables to operate microphones that contain active electronic circuitry.
subwoofer	Loudspeaker for low bass sounds.
ultra-short throw projector	Ultra-short-throw (UST) projector is a type of projector that uses special lenses and mirrors to cast a large image from a short distance.
USB dongle	A dongle is a small piece of computer hardware that connects to a port on another device to provide it with additional functionality or enable a pass-through to such a device that adds functionality.

3 PRODUCT DESCRIPTION

Artome M10 is a smart furniture that has an integrated laser projector, embedded sound system, and a videoconferencing feature.

Artome M10 is designed for easy presentation, multimedia experience or hybrid working. Artome M10 is an all-in-one product for any space due to its portability and fully adaptable image size, with automated use and the basic control panel.

A laminated Artome M10 - Quick User Guide inside Artome is intended for the users who want to get more out of connectivity and get more operational or other info.

Basic User Guide is also available to learn about the product and to get started with it.

3.1 Intended Use

Artome M10 is intended to be used as a local presentation device or as the mobile all-in-one solution in different videoconferencing events. The product includes a pre-installed Epson projector for displaying a scalable image for different surfaces, embedded sound system which consists of embedded mixer, an active speaker system, and connections for videoconferencing devices.

CAUTION



Do not use Artome M10 outdoors. Check the allowed temperature ranges in technical specifications.

The Artome M10 is compatible with the following Epson projector models: Epson EB-800F/EB-805F / Epson Powerlite EB-800F/EB-805F

The User's Guide of the selected projector is provided with Artome M10 if it is included in Epson package. Please notice that the Epson projector can only be installed by Artome or an authorized partner of Artome.



DISCLAIMER: THIS DOCUMENT DOES NOT COVER SETUPS INCLUDING ADDITIONAL DEVICES ALTHOUGH THIS DOCUMENT INCLUDES EXAMPLE SETUPS WITH ADDITIONAL DEVICES.

3.2 Product Overview

Artome M10 is a piece of furniture with built-in audiovisual technology. It displays an image of up to 150" with an integrated Epson laser projector, produces sound through embedded sound system and enables easy video conferencing with camera and microphone connections. The furniture can be customized with different cabinet finishes and a range of upholstery colors.

Figure. 3.2 - 1. Parts of M10

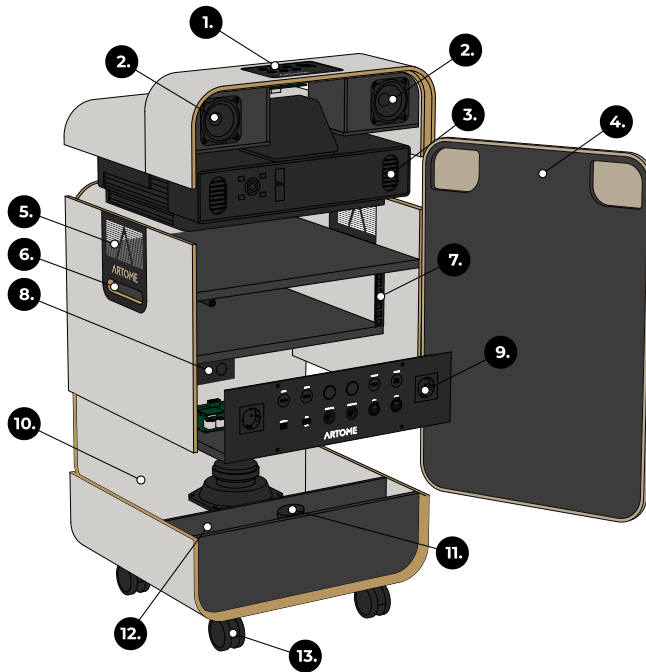

Number	Description
1	User panel for controlling Artome M10 and the Epson projector
2	Speakers
3	Attaching points for Epson projector
4	Push-to-open door
5	Fans for projector air ventilation
6	Handles for moving the product
7	19" rack space for auxiliary devices
8	Mains power connection
9	Connection panel with connections for audio, video, and data transmission
10	Subwoofer speaker
11	Cable grommet for cable management
12	Storage space for cables and accessories
13	Castors



Epson projector is excluded as the Epson User's Guide is an individual document.

3.3 Product features

3.3.1 Projection and imaging

Artome M10 image features are based on Epson laser projector platform. All the features can be used with Epson's own user interface. However, the main functions such as Projector On/Off, Freeze, AV Mute, and Zoom in/out functions can be controlled by the Artome M10 user interface. For example, if the projector is switched on with Epson user interface or by a third-party system, Artome M10 unit identifies the function and powers on.

Artome M10 takes care of the ventilation of the projector by letting the cool air in and warm air out through its built-in ventilation system. The projector also has a temperature sensor as a safety mechanism.

The Artome M10 connection panel transmits HDMI and HdBaseT -video signals with a pass-through cable to and from the Epson projector.

3.3.2 Sound

The Artome M10 sound system is an active speaker system with two front speakers and a subwoofer for low bass (2.1 audio system). Artome M10 is equipped with a line out to attach external speakers or transfer signal to other sound systems. It also supports plug-and-play connections to microphones.

Sound is processed with Artome Digital Signal Processor (DSP) and amplified with embedded D-class amplifier. Sound from the HDMI and HDBaseT source is de-embedded by the Epson projector.

Artome HybriDock™ is a USB audio interface which converts analog audio sources, such as microphones to digital USB microphones and transmits USB audio from a laptop to the Artome M10 sound system.

Notice that the sound capacity depends on the room acoustics and size. Test if the Artome M10 sound system capacity is enough for the location. To amplify the sound with additional speakers or sound system, use the Audio Out connection.

3.3.3 Wireless connections

Use all wireless media adapters with an HDMI connection with Artome M10. For further information, view the manual of the preferred wireless media adapter you want to use with Artome M10. Ask for recommendations from your company IT department or Artome reseller.

3.3.4 Videoconferencing

1. Connect the HDMI and USB cables to your laptop. Artome M10 powers on automatically.
2. Check the settings of your videoconferencing software:

- **Camera** —**The name of the USB camera** - Uses the camera connected to Artome as the image source.
- **Speaker** —**The name of the speakerphone** - Speakerphone plays back the laptop content including the video call audio.
- **Microphone** —**ARTOME Hybri**. Use speakerphone as the audio source.

3.3.5 Hybrid events and learning

Artome M10 enables an easy streaming solution for events and hybrid learning. While it produces a big image and sound locally, and amplified speeches with microphones. It also streams image and sound by using videoconferencing or streaming software.

In this use case, the web camera is typically installed on the camera stand shooting the presenter. It is connected with a long USB cable to Artome M10 or straight to the host computer. The speech microphone is transmitted by videoconference software using the Artome HybriDock feature, which transforms the analog audio to USB audio.

3.4 Using Radio Equipment

Artome M10 is not manufactured or intended to be used with a radio equipment. You can connect an external radio equipment to Artome M10 and use it as a mobile audiovisual solution. Artome takes no responsibility if a radio equipment is used but can recommend devices manufactured by other vendors.



Radio Equipment Directive 2014/53/EU requires that in cases of restrictions on putting into service or of requirements for authorization of use, information available on the packaging shall allow the identification of the Member States or the geographical area within a Member State where restrictions on putting into service or requirements for authorization of use exist and that such information shall be completed in the instructions accompanying the radio equipment.

4 UNPACKING

Packaging includes:

- Artome M10 with pre-installed Epson ultra-short throw projector.
- Artome with pre-installed Epson projector.
- Epson remote control.
- 4 m HDMI-USB cable.
- Magnet stand for USB camera with 15 cm flat USB 3.0 cable.
- Artome M10 - Quick User Guide.
- Artome M10 - Safety documentation.
- Artome M10 carton box.

Optional:

- Microphone with cable.
- Wireless microphone receiver and transmitter.
- USB camera.
- USB microphone.
- Camera leg with long USB cable.

5 USER INTERFACE AND CONNECTIONS

5.1 Control Panel

You can find the control panel on top of the device.

Figure. 5.1 - 2. Control panel

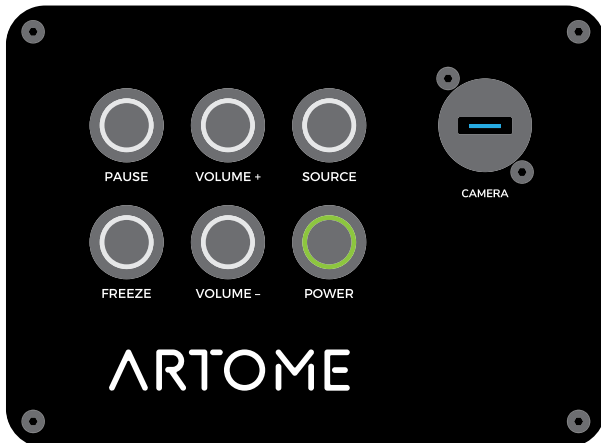





Table. 5.1 - 3. Control panel features

Button or connector	Description
PAUSE	Turn off the image and the sound. To restore image and sound, press again.
FREEZE	Freeze the image, but not the sound.
VOLUME + or VOLUME -	Adjust the volume.
SOURCE	Select the audio and video source.
POWER	Turn the unit on or off.
CAMERA	Connection for a USB camera.

5.2 Light indicators

Table. 5.2 - 4. Light indicators

Indicator	Button	Status	Description
	Pause	On	Sound muted and image turned off
		Off	Sound and image turned on
	Freeze	On	Image frozen. To shift the image height, press the volume+ and volume- buttons
		Off	Image freeze-up off
	Power	On	Power on
		Blinking	Warming up
		Off	Power off

5.3 Connections

You can find the connection panel behind the front door.

Figure. 5.3 - 3. Connections

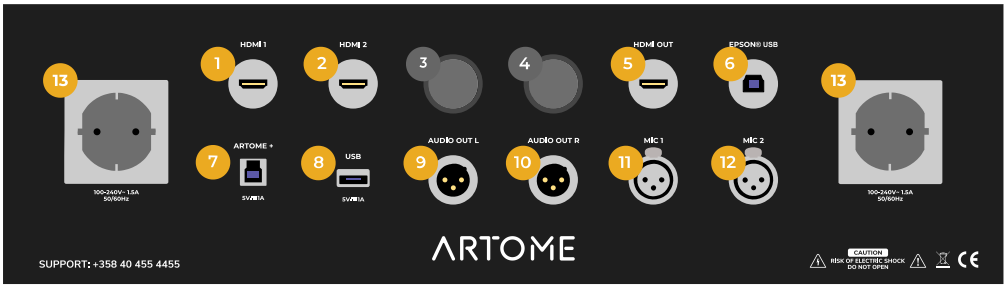
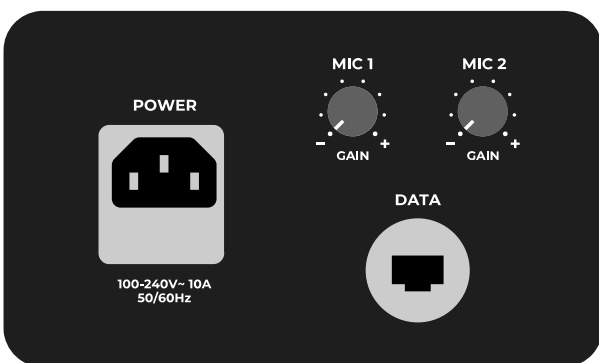

Table. 5.3 - 5. Connections

Connector number	Description
1, 2 HDMI 1 & HDMI 2	HDMI audio and video inputs.
3,4 [blank]	Additional connections for customized features.
5 HDMI OUT	Video output.
6 EPSON® USB	Miracast® wireless casting or USB media playback.
7 ARTOME+	Connection between video conferencing devices and a computer.
8 USB	Connection for additional devices like a wireless speakerphone receiver.
9, 10 AUDIO OUT L & R	Audio outputs for external speakers. Balanced stereo 0dBV.
11, 12 MIC 1 & MIC 2	Connection for a wired microphone or a wireless microphone receiver.
13 POWER SOCKET	Power output 100-240V ~ 1.5A 50/60Hz

Figure. 5.3 - 4. Power and data connection



Connection	Description
POWER	Connection to main power.
MIC 1 & MIC 2	Gain control for mic input volume.
DATA	Connection for data transfer with HDBaseT / LAN.

6 PREPARATIONS

6.1 Connecting additional devices

Artome M10 is a mobile solution which operates also as a mobile rack for additional devices. In an all-in-one solution, dimensions of cabling are short and cable management is easy.

Figure. 6.1 - 5. Rack space



Figure. 6.1 - 6. System diagram

See the system diagram below for connecting additional devices.

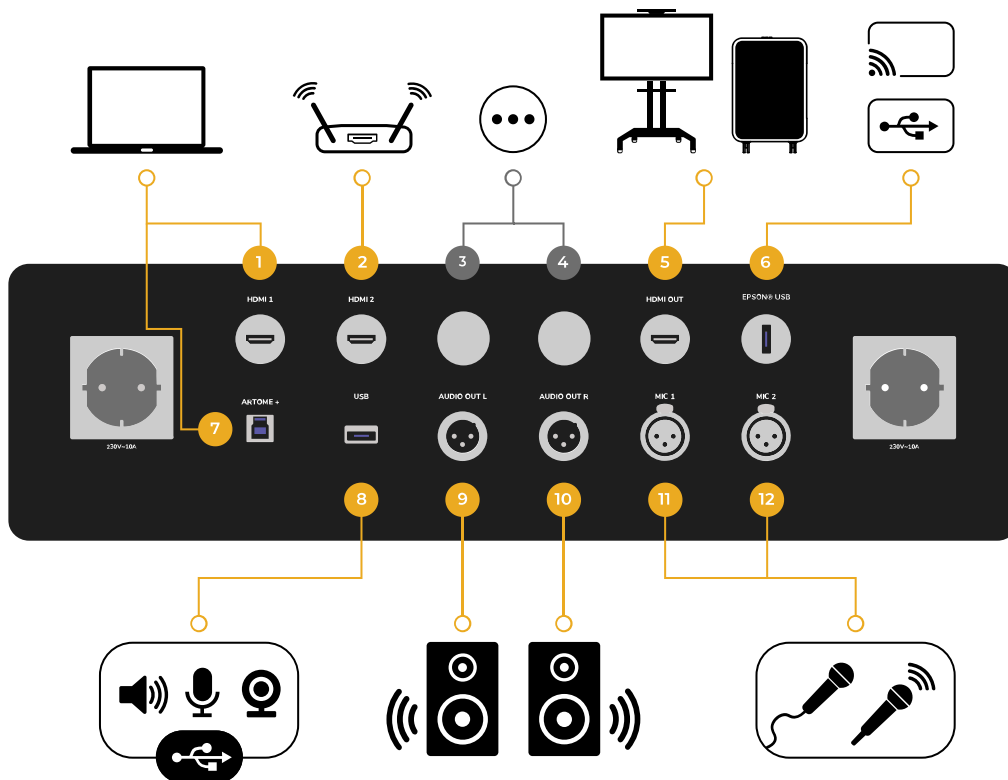

Figure. 6.1 - 7. System diagram

Number	Connection name	Device
1	HDMI 1	Laptop
2	HDMI 2	Wireless streaming device
3	OPTIONAL	LAN / AV over IP
4	OPTIONAL	Miracast® wireless casting or USB media playback
5	HDMI OUT	External display
6	EPSON® USB	Miracast® wireless casting or USB media playback
7	ARTOME+	Laptop
8	USB	Speakerphone, microphone, or camera
9	AUDIO OUT L	Left audio channel for external speakers (line out 0dB)
10	AUDIO OUT R	Right audio channel for external speakers (line out 0dB)
11	MIC 1	Wired microphone or wireless microphone system
12	MIC 2	Wired microphone or wireless microphone system

6.1.1 Microphones

MIC1 and MIC2 connections are for analog microphones.

Before selecting a microphone for Artome M10 take the following subjects under consideration:

- Artome recommends dynamic cardioid (or hyper-/super cardioid) microphones to minimize feedback and optimize the sound pressure.
- When using microphones with cables, input gain is fixed and is optimized for dynamic microphones with an impedance of 350 ohm.
- Microphone input does not provide phantom power, so using condenser microphones will require additional phantom power supply.
- When using rack mounted wireless microphones, ensure that the microphone receiver depth is not more than 260 mm with the cable and the gain can be adjusted from the microphone system.

For preferred microphones and wireless microphone systems, ask your Artome reseller.

6.1.2 External sound system

Artome includes stereo audio out connection for connecting additional sound systems or audio devices, such as recorders to Artome solution.



- The audio out signal is not processed, but signals are mixed with the embedded DSP mixer.
- Gain in Audio Out is 0 dB.
- Artome M10 sound system cannot be muted when using Audio Out. Adjust the gain from the additional sound system to turn up or down the sound.

6.1.3 Installing Web camera

Videoconferencing

1. Attach the magnetic foot to the bottom of the camera.
2. Connect the USB cable to the camera.



3. Place the camera at the front edge of the control panel and connect the USB cable to the connector.



Events

Install the camera to an appropriate location with the magnet leg or an optional camera stand. Connect the camera to the USB port of Artome connection panel or straight to the host computer.

If you are using a USB 3.0 camera, please note that the cable length can only be 1,8 m long to ensure the operation of the camera. For longer distances than 1,8 m, Artome recommends USB 2.0 cameras or a camera with an additional power supply

6.1.4 Installing speaker phone

When Artome M10 is used for videoconferencing, it is preferred to use additional speakerphones. A speakerphone enables interactive discussion and there is no need for local speech reinforcement. In a remote meeting a speakerphone also operates as a speaker system.

Figure. 6.1.4 - 8. Speakerphone



Artome recommends using speakerphones with Bluetooth USB dongles or long USB cables. Connect a wireless Bluetooth USB-dongle or a USB cable to the USB connector of Artome M10. Be sure to charge the speakerphone and turn it off after use.

6.2 Image adjustment and unit placement

6.2.1 Optimizing image

To fully project the image, do not use Artome M10 next to an object taller than 78 cm / 30.7 inches (see fig. 7).

To ensure proper air ventilation, leave at least 15 cm / 6 inches of free space on both sides of the Artome M10 during use.

Figure. 6.2.1 - 9. Unit placement

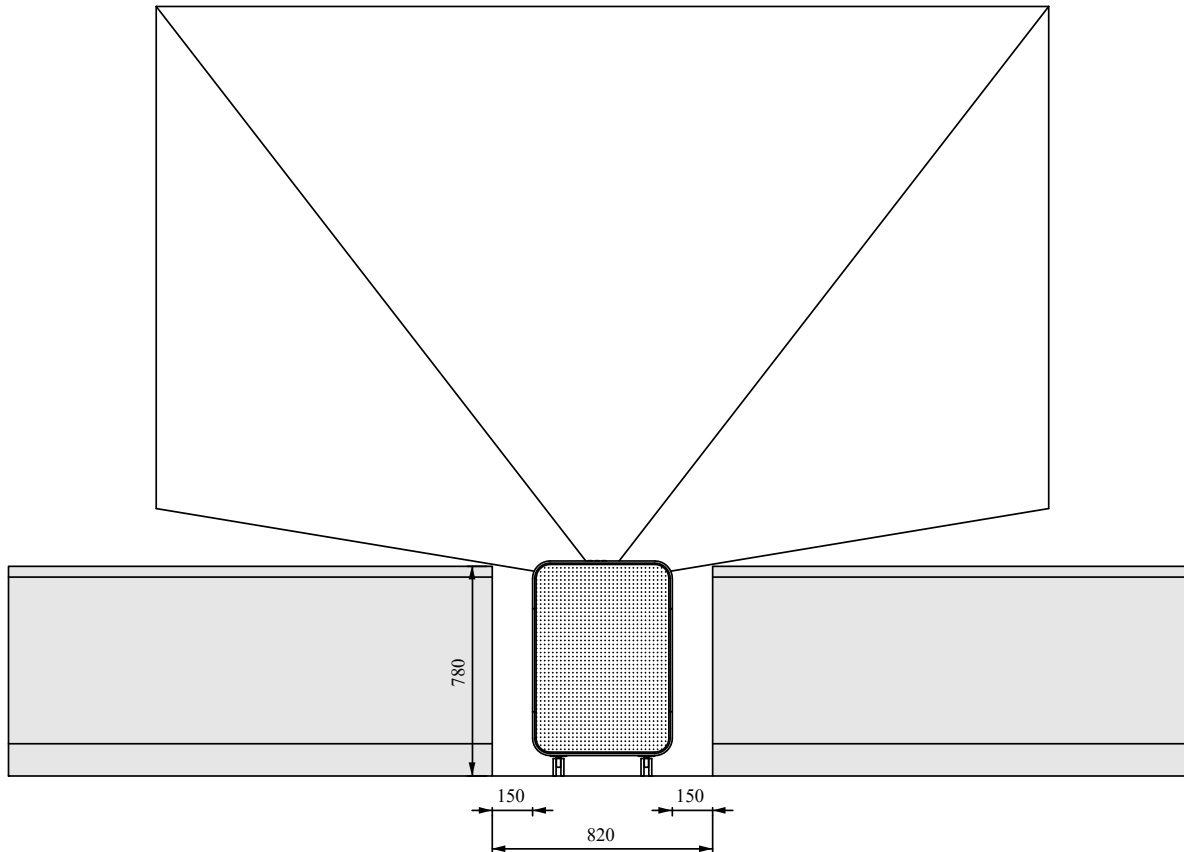

6.2.2 Adjusting image size

To increase the image size, move M10 further away from the projection surface. See image below.

To decrease the image size, move M10 closer to the projection surface.

To adjust the image digitally,

1. Press **Freeze**.
2. To decrease image size, press **Vol -**
3. To increase image size, press **Vol+**.
4. To save the changes, press **Freeze** again.

Table. 6.2.2 - 6. Image size cf. distance

Image size	Distance from wall
60"	5 cm
150"	60 cm

Figure. 6.2.2 - 10. Image size compared to the distance

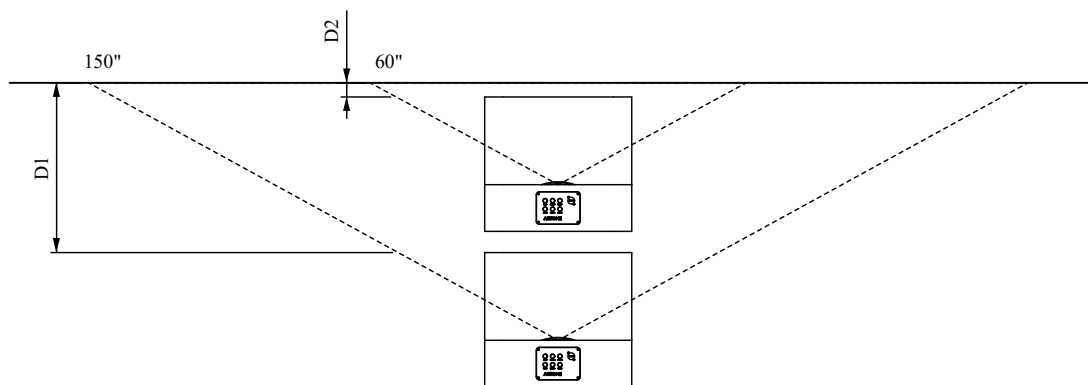

6.2.3 Adjusting focus

1. To open the front door, press the door at the upper left corner.
2. Adjust the focus.

Figure. 6.2.3 - 11. Adjusting the focus.

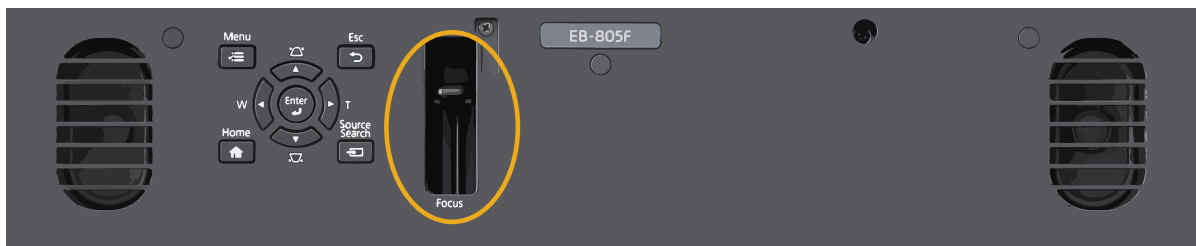

6.2.4 Adjusting image shape

To correct an image that is slanted on the sides, use the projector's keystone correction buttons (see figure below).
To open the front door, press the door in the upper left corner.

Figure. 6.2.4 - 12. Adjusting image shape

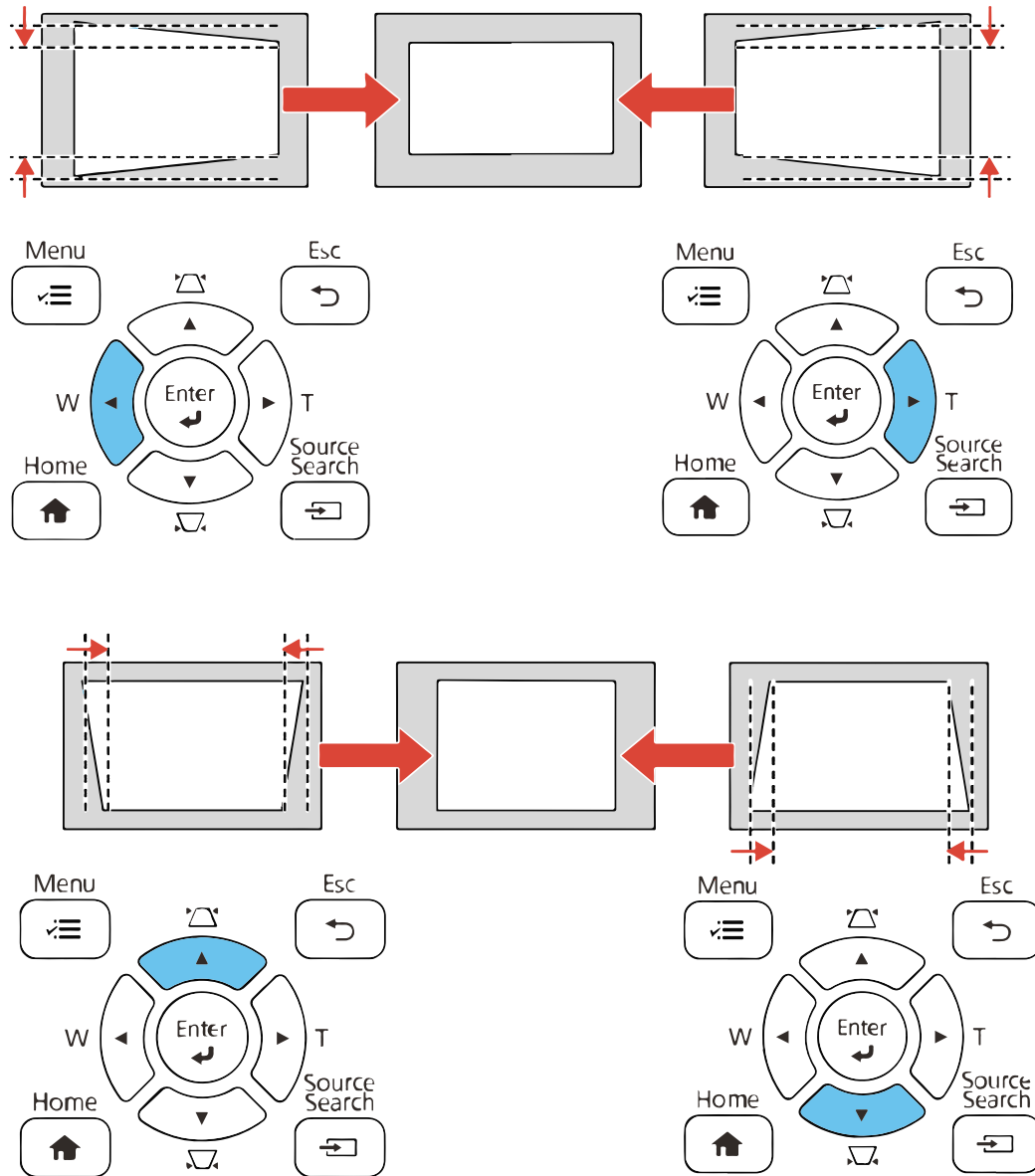

6.2.5 Lifting the image

1. To activate image lift, press **Freeze**.
2. To lift the image, press **Volume -**. This reduces the size of the image and raises the image.
3. Move Artome M10 away from the projection surface. Image size increases.
4. To save the adjustment, press **Freeze** again.



Artome M10 uses the Epson ultra-short throw projector for image projection and the image is always fixed. However, the image can be lifted by zooming out the image and then using the image shift function. This may cause a reduction in image quality. To get the best possible image quality, restore the image back to its native size.

7 FIRST TIME USE



1. Open the back door by pressing on the upper right corner.



2. Feed the power cable through the cable grommet and connect the cable to the **POWER** connector.



3. Feed the HDMI-USB cable through cable grommet and connect the cable to the **HDMI** and **ARTOME+** connectors.



4. Connect HDMI-USB cable to your computers HDMI and USB A-ports. Use a suitable adapter if necessary.



5. Power on the unit by pressing the **POWER** button.

6. Adjust the output volume with your laptop or with Artome X20 **VOLUME +/-** buttons

8 DAILY USE

8.1 Connecting with a wire

1. Connect the HDMI cable to the HDMI connections of the laptop and the Artome X20.
2. Power on Artome X20 by pressing the **POWER** button.
3. Press the **SOURCE** button to select between video sources when multiple video sources are connected at the same time.
4. Use the **FREEZE** function to freeze the picture without stopping the sound.
5. Use the **PAUSE** button to pause both the picture and sound without turning off the device.

If the laptop is not detected within 20 minutes, Artome X20 shuts down.



To save energy, Artome recommends shutting down the device

8.2 Connecting with a wire

1. Connect the HDMI cable to your laptop. Artome M10 powers on automatically when connected to the **HDMI1** input.
2. If there are multiple sources connected simultaneously, to select the source, press the **Source** button.
3. Use **Freeze** or **Pause** if necessary.

If the laptop is not detected within 20 minutes, Artome M10 shuts down.

8.3 Wireless connections

Wireless sharing technology is not included by default, but M10 can be easily connected to any wireless collaboration system with HDMI.

This manual does not include the operating instructions of other vendors. For further information, check additional guides from your reseller or IT department.

8.4 Videoconferencing

1. Connect the HDMI and USB cables to your laptop. Artome M10 powers on automatically.
2. Check the settings of your videoconferencing software:
 - **Camera** —**The name of the USB camera** - Uses the camera connected to Artome as the image source.
 - **Speaker** —**The name of the speakerphone** - Speakerphone plays back the laptop content including the video call audio.
 - **Microphone** —**ARTOME Hybri**. Use speakerphone as the audio source.

8.5 Streaming – Hybrid events and hybrid learning

1. Connect the HDMI and USB cables to your laptop. Artome M10 powers on automatically
2. Check settings of your videoconferencing software
 - **Camera** — **The name of the USB camera**. Uses camera connected to Artome as the image source
 - **Speaker** —**ARTOME HybriDock**. Artome speakers play back laptop content including the video call audio
 - **Microphone** —**ARTOME HybriDock**. Uses Artome MIC 1 and MIC 2 connections as the audio source.

8.6 Audio use

1. Connect the USB cable to the USB connection of the laptop and the **ARTOME+** connection of the Artome M10.
2. To power on Artome M10, press the **POWER** button
3. Select **Artome HybriDock** as the as the audio output device on your laptop.
4. Adjust the volume with your laptop or with Artome M10 **VOULUME +/-** buttons.

9 MAINTENANCE

9.1 Cable management

- Disconnect any unnecessary cables and put them neatly inside the storage space.
- Make sure that the necessary cables are firmly connected and enter the casing through the cable grommet at the bottom.

9.2 Cleaning the casing

Exterior

1. Wipe the exterior surfaces (excluding the front door, the projector lens, and the user panel) with a damp cleaning cloth and neutral detergent.
2. After wet wiping, wipe the surfaces dry.



Keep the exposure time of chemicals on surfaces to the minimum and avoid excessive abrasion.

Interior

1. Open the back door by pushing its upper left corner.
2. Wipe the interior surfaces with a dust-binding cleaning cloth.

Door upholstery

- Dry clean the fabric of the door using a vacuum cleaner with an upholstery tool.



If the front door fabric gets damaged or stained uncleanable, please contact Artome for a spare part.

9.3 Vacuuming the projector space and fans

- Clean the projector casing with a vacuum cleaner equipped with a crevice nozzle. Clean under the projector and around the fans on both sides of the cabinet.



Dust may block air ventilation for the projector and cause the projector warming up.

9.4 Cleaning the lens

- Clean the projector's lens periodically, or whenever you notice dust or smudges on the surface. Make sure you unplug the projector before cleaning the lens.
- To remove dust or smudges, gently wipe the lens with lens-cleaning paper.
- To remove stubborn smudges, moisten a soft, lint-free cloth with lens cleaner and gently wipe the lens. Do not spray any liquid directly on the lens.



WARNING

Do not use a lens cleaner that contains flammable gas. The high heat generated by the projector may cause a fire.

Do not use glass cleaner or any harsh materials to clean the lens. Do not subject the lens to any impacts; you may damage it. Do not use canned air, or the gases may leave a residue. Avoid touching the lens with your bare hands to prevent fingerprints or damage to the lens surface.

9.5 Product service program

Table. 9.5 - 7.

Task	Frequency
Projector air filter cleaning or replacement	Every 12 months
Testing operation including all connections	Every 6 months
Cleaning the furniture	Every month
Vacuuming the projector space and fans	Every month

10 TROUBLESHOOTING

Error	Typical cause	Solution
Product does not start.	Power cable is not connected correctly or there is no power in power outlet.	Check power cable connection and Replace part A. See 9.2.4.1 Replacement of Part A.
Product is powered correctly, but product does not start.	Power fuse of Artome M10 is burned or broken device.	Check connection panel power outlets with laptop. If power is fed to laptop, fuse is not burned. If power not fed to laptop fuse is burned. In both issues, contact local reseller or Artome Service.
Overheat warning and projector turns automatically off.	Room temperature is too high, or Epson projector air filter is too dusty.	Ensure that the room temperature is less than 30 °C / 86 °F and try again. If the problem still occurs, air filter of projector might be dusty and requires cleaning or replacement. Contact local reseller for service.
HDMI image is not found	HDMI cable is not connected, or HDMI cable or HDMI adapter is broken.	Check connection of source device and connection panel. Try another cable and/or another HDMI port. If problem still occurs, contact local reseller or Artome Service.
Projector is showing wrong content.	There are multiple sources connected to Artome M10 and the wrong source is selected as active.	Push source button to select the correct source.
Laptop is connected but can't see icons from my desktop.	Laptop recognizes Artome M10 as extended display.	Change laptop display settings.
Image is too small.	Zoom Out function is decreasing the size of the image.	Press Freeze button and Volume Up to adjust image bigger.
Laptop volume is not adjusting Artome volume.	With Apple computers there is no volume adjustment in HDMI output.	Using Artome HybriDock as speaker will solve the problem.
USB camera and USB speakerphone is not working.	Laptop and USB device is not connected.	Check that USB cable is connected correctly between Artome M10 and laptop.
USB camera is not working when using longer USB cable.	If the camera requires USB3.0, maximum length for cable is 1.8 m/6ft to power the camera.	Use USB2.0 camera or USB camera with separate power supply.
There is feedback in microphone.	Microphone sensitivity is too high for Artome M10 gain.	Use dynamic microphone with impedance of 330-380 ohm.

11 SUPPORT AND SERVICE

For any questions, information, technical assistance, service, or ordering user instructions, please contact first your local reseller or distributor. If the reseller and/or distributor cannot provide the required info, contact the manufacturer:

Artome Ltd

Syrjäläntie 81

19110 VIERUMÄKI

FINLAND

Tel: +358 40 455 4455

e-mail: contact@artome.fi

www.artome.fi

11.1 Getting more information

Besides these user instructions, the following documentation is available:

- Artome M10 - Quick User Guide
- Declaration of Conformity

Ordering Documentation

For more information or additional documentation, please contact Artome by email: contact@artome.fi.

The documentation for this product is available in multiple languages, please contact us by email if you require another language.

Documentation Feedback

Any feedback about our documentation, please email us at contact@artome.fi.

We appreciate your comments.

12 DISPOSAL

12.1 Disposal of electronic components

The symbol on the product, the accessories or packaging indicates that this device must not be treated as unsorted municipal waste but must be collected separately! Dispose of the device via a collection point for the recycling of waste electrical and electronic equipment if you live within the EU and in other European countries that operate separate collection systems for waste electrical and electronic equipment. By disposing of the device in the proper manner, you help to avoid possible hazards for the environment and public health that could otherwise be caused by improper treatment of waste equipment. The recycling of materials contributes to the conservation of natural resources. Therefore, do not dispose of your old electrical and electronic equipment with unsorted municipal waste.

Figure. 12.1 - 13. Not municipal waste

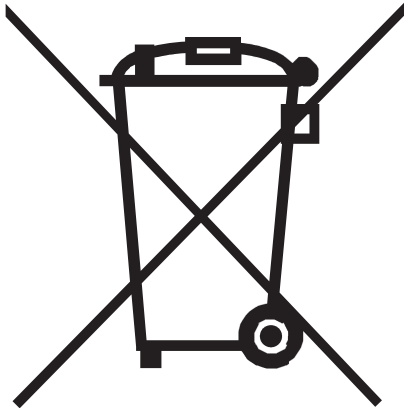

12.2 Disposal of packaging waste

The packaging is made of environmentally friendly materials, which may be disposed through your local recycling facilities. By disposing of the packaging and packaging waste in the proper manner, you help to avoid possible hazards for the environment and public health. The symbol on the packaging indicates that the packaging is made of PAP.

13 TECHNICAL DATA

13.1 General specifications

Name	Artome M10
Product description	All-in-one audiovisual cart.
Materials	Birch plywood, MDF, steel, aluminum, fabric (PES)
Dimensions (width*depth*height)	(W x H x D) 52 x 80 x 47,5 cm / 20.4" x 31.4" x 18.7"
Weight	40 kg / 88 lbs (without projector)
Warranty	24 months (option to extend up to 60 months)

13.2 Technical specifications

Supply voltage	100-240 V, 50-60 Hz
Power consumption (excl. projector)	156 W
Sound	2.1 -speaker system. Max. SPL 99 dB @ 1 m
Operating temperature	0-30 °C / 32-86 °F
19" rack	3U x 257 mm (depth)
Controls	Power, Source, Vol +/-, Pause, Freeze, Mic gain
Connections	HDMI in x2, HDMI out, Mic in x2, Stereo audio out (balanced), HDBaseT power outlet x2 (100-240V~ 50/60Hz)
Artome HybriDock	USB 3.0 hub, USB audio interface

13.3 Projector specifications

Compatible projectors	Epson EB-800F/805F
Brightness	5,000 lm
Power consumption	366 W
Resolution	1080p
Aspect ratio	16:9
Recommended image size	60-150"
Weight (incl. lens)	9,4 kg / 20.7 lb
Warranty	60 months or 12,000 h